

OUTDOOR LIGHTING

EXTRO SYSTEM

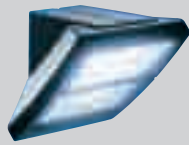

EXTRO



POLES

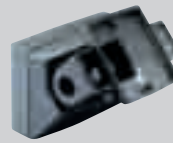

SUPPORTS

WATERTIGHT LUMINAIRES

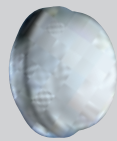

BOLLA 200

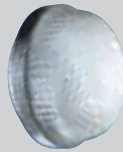

BOLLA 260

WATERTIGHT LUMINAIRES



GUSCIO 250



GUSCIO 250 photoelectric cell



GUSCIO 320

PROTECTED LUMINAIRES



TONDA 180



TONDA 230

RESIDENTIAL AREAS



GLOB pole



GLOB wall



POINT



PARK

SELECTION GUIDE

INCANDESCENT SOURCES			POWER (W)				
			25	40	60	75	100
EXTRO							
BOLLA		200					
		260					
GUSCIO		250					
		320					
TONDA		180					
		230					
GLOB POLE GLOB WALL							

COMPACT FLUORESCENT SOURCES WITH BUILT-IN SUPPLY UNIT*			POWER (W)					
			5	7	11	15	20	23
EXTRO								
BOLLA		200						
		260						
GUSCIO		250						
		320						
TONDA		180						
		230						
GLOB POLE GLOB WALL								

* Reference data based on the dimensions of the sources of the main manufacturers, to be verified.

DISCHARGE LAMPS			
		POWER (W)	
MERCURY			80
SODIUM		70	
METAL HALIDES			100
EXTRO			

COMPACT FLUORESCENT SOURCES															
POWER (W)		7		9		11	13		16	18	26		28	32	
NUMBER OF LAMPS		1	2	1	2	1	1	2	1	2	1	2	1	1	2
EXTRO															
BOLLA		200													
		260													
GUSCIO		250													
		320													
TONDA		180													
		230													
POINT		Small Point													
		Point													
PARK		Small Park													
		Park													

SELECTION GUIDE

EXTRO 2X18W FSQ

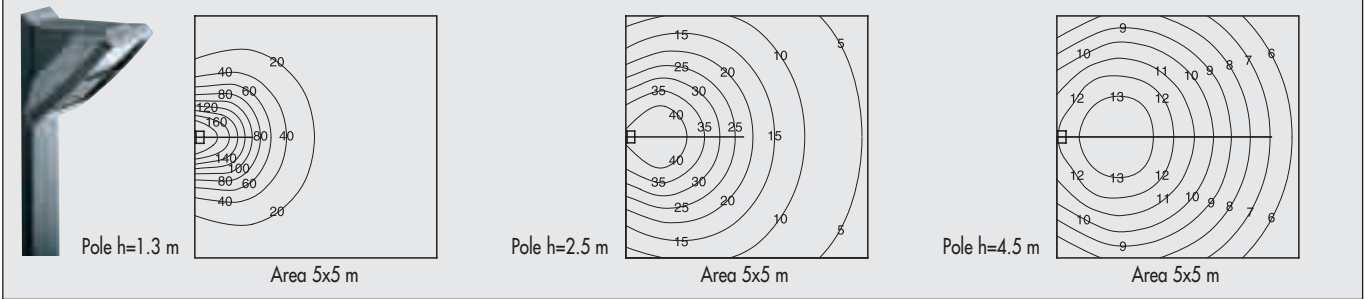

EXTRO 2X26W FSQ

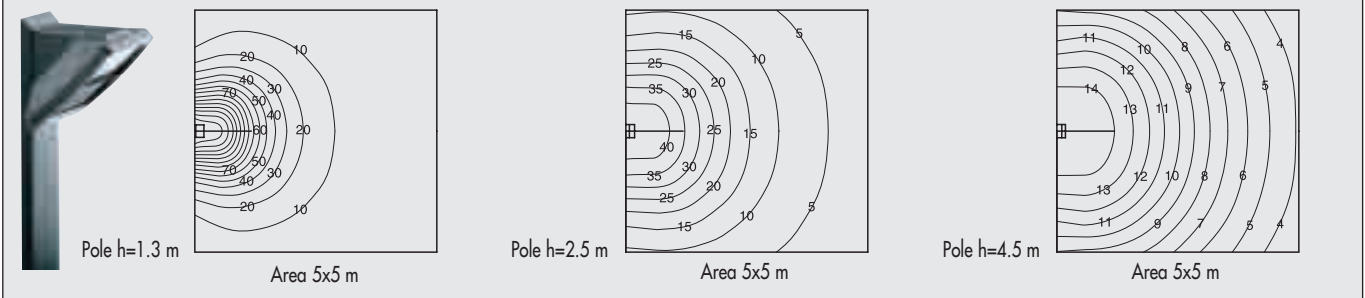

EXTRO 2X32W FSQ

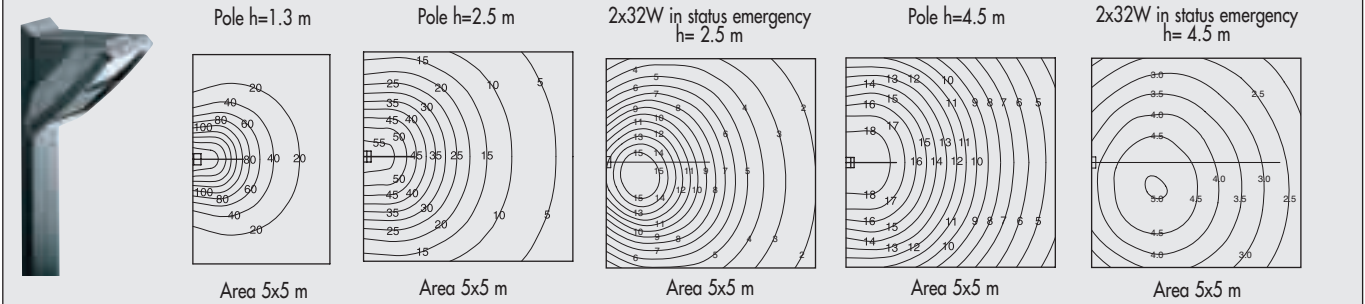

EXTRO 70W SE

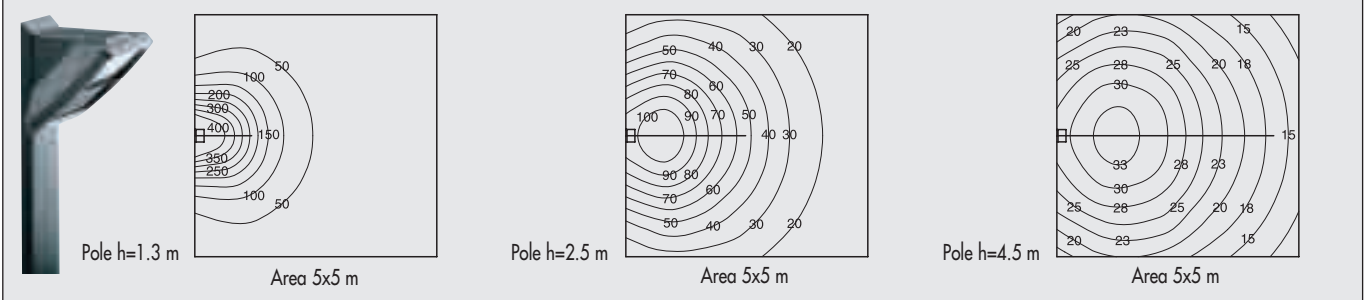

EXTRO 100W ME

